



# HD Pal Series User Manual



Copyright © 2021. All rights reserved

## Disclaimer

EZ Dupe's duplicator machine is specially designed for data backup of storage devices. Please observe the relevant provisions of copyright when using it. Any backup without the consent or authorization of the copyright holder is illegal. Please confirm before backup. EZ Dupe is not responsible for any illegal acts, and the user is responsible for all legal liabilities.

The source port of duplicator is write-protected, and the settings and data content of any storage device in the source port will not be changed at all. Do not place the source storage device on the target port to avoid accidentally changing (deleting) of data. It has nothing to do with EZ Dupe if there is any mistake in correcting (deleting) the data by user. In addition, EZ Dupe is not responsible for the risks and data losses incurred as a result of duplication. By purchasing this product, the user accepts this statement and agrees to be bound by it.

The content of this manual is for reference only. The copyright of the content belongs to EZ Dupe. Please do not copy or repost it without authorization. EZ Dupe reserves the right to change the function of the product without prior notice.

## Before Use

1. Please read this manual carefully before operation to avoid any misconduct.
2. Make sure that the storage device you want to use is of good quality and can be used normally.
3. The capacity of target storage device must be greater than or equal to the capacity of source storage device to avoid incomplete data backup.
4. It is recommended to use the Copy + Compare function when backing up, to ensure that the backup data is 100% the same as the source data, because the target storage device may have write errors or damaged sectors.
5. When updating the firmware, please do not turn off the power. If the power is interrupted accidentally, the machine cannot be turned on, and it must be returned to the factory for processing.
6. Keep the duplicator used in a dry environment. Rain, moisture, liquid, etc. may corrode the circuit board and cause the machine to malfunction.
7. Avoid using the duplicator in dusty or dusty environments. Dust may cause bad contact with the port.
8. This product warranty does not apply to accident, man-made destruction, abuse, or improper use (such as using not in accordance with the product description, or intended to exceed the scope of use for which this product was designed, or improper use of fixtures, etc.)
9. If the duplicator performs normally, it is strongly recommended not to update the firmware, unless there is a problem in use or a new function is required.
10. For convenience, the source storage device will be referred to as the source device, and the target storage device will be referred to as the target device in this manual. The storage device used can be USB flash drive, SD or CF memory card based on the model of duplicator.

<b>I. INTRODUCTION.....</b>	<b>5</b>
-----------------------------	----------

1. Features.....	5
2. Kit Contents.....	6
3. Outlook Overview.....	7
4. Control Panel Overview.....	8
5. Specifications.....	9
<b>II. WARNING.....</b>	<b>10</b>
<b>III. OPERATION OVERVIEW.....</b>	<b>11</b>
<b>IV. MENU OVERVIEW.....</b>	<b>13</b>
1. Duplicate.....	13
1.1 Copy.....	13
1.2 Compare.....	15
1.3 Copy + Compare.....	15
2. Data Erase.....	15
2.1 Quick Erase.....	15
2.2 Full Erase.....	16
2.3 3-Pass DoD Erase.....	16
2.4 7-Pass DoD Erase.....	16
2.5 Secure Erase.....	17
2.6 Enhance Secure Erase.....	17
2.7 Remove HPA.....	18
2.8 Remove DCO.....	18
3. PC Mode (HD Pal / HD Pal Pro Only).....	18
4. Utility.....	18
4.1 Format FAT32.....	18
4.2 Format exFAT.....	19
4.3 Measure Speed.....	19
4.4 Media Information.....	19
4.5 Device Information.....	20

4.6	Log Manager(HD Pal / HD Pal Pro only)	20
4.7	File Manager	22
4.8	Print Last Task Label (HD Pal Pro only)	24
4.9	System Info	24
4.10	System Update	24
<b>5.</b>	<b>Setup</b>	<b>24</b>
5.1	Operation Mode	24
5.2	Copy Area	25
5.3	Smaller Target	26
5.4	Unknown Format	26
5.5	HPA Set	26
5.6	DCO Set	27
5.7	Allow Reader Bad Sector	27
5.8	Erase Master	27
5.9	Label Print (HD Pal Pro only)	28
5.10	Start-up Menu	28
5.11	Button Beep	28
5.12	Language	28
5.13	Clear Setup	28
5.14	Set Date Time (HD Pal / HD Pal Pro only)	29
5.15	Performance	29
<b>V.</b>	<b>TROUBLESHOOTING</b>	<b>30</b>

## I. Introduction

This duplicator system is designed and developed based on the FPGA from the world famous semiconductor company XILINX. Every processing channel is parallel to each other with its own control unit, therefore the duplicator will not sacrifice speed for the increasing number of targets loaded - always remain the same and fast copy speed. The duplicator supports fast copy with multiple file formats created by three major operating systems (Windows/Linux/MAC), and makes mirror copies of data efficiently. Furthermore, this duplicator has been fully tested with quality assurance before leaving our manufacturing facility.

### 1. Features

- a. Each processing channel has its own control unit and operates independently with dedicated bandwidth of up to 600 MB per second.
- b. Standalone operation. No PC or software is required, minimizing possible computer virus infection.
- c. Instant power on and off, no warm-up or cool-down required.
- d. Easy-to-use One-Touch copy operation.
- e. Compare function available for verification of copy accuracy
- f. Menu options are user-friendly and easily accessed through the 4-button control panel. Use ▲ or ▼ button to scroll through the options and view the operation status of each channel on the 2-line backlit LCD display.
- g. Support Synchronous and Asynchronous copy modes for best operation efficiency.
- h. Powerful 32-bit CRC checksum to assure data integrity.
- i. Heavy-duty hardware construction for commercial production or personal use.
- j. 115V and 230V switching power supply maximizes portability for operation anywhere.
- k. Designed to save users time and effort in creating multiple copies quickly and reliably.
- l. Unique source data analysis to copy data area only to achieve highest efficiency
- m. Supports multiple file formats: Windows: FAT 16/32、exFAT、NTFS, Linux: ext 2/3/4,

Mac: HFS/HFS+/HFSX

## 2. Kit Contents

The kits contained in the box are as follows :

Kit	HD Pal Jr.	HD Pal	HD Pal Pro
HD Pal Unit	v	v	v
Power Adapter	v	v	v
Power Cord for Adapter		v	v
SATA Extension Cable	x2	x4	x4
SATA to IDE Adapter with Power Cable	x2	x4	x4
USB 3.0 Cable A to B		v	v
Sticky Semi-Transparent Paper			x2
Disc User Manual	v	v	v

### 3. Outlook Overview

HD Pal Jr.

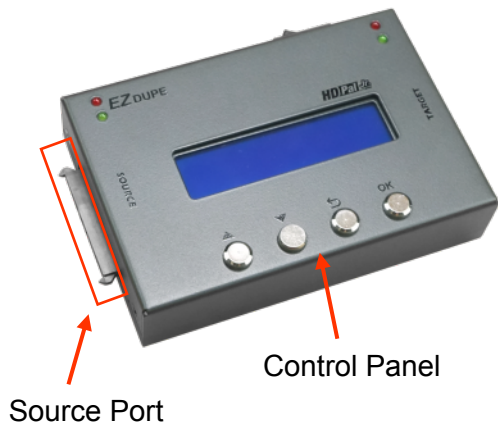

HD Pal

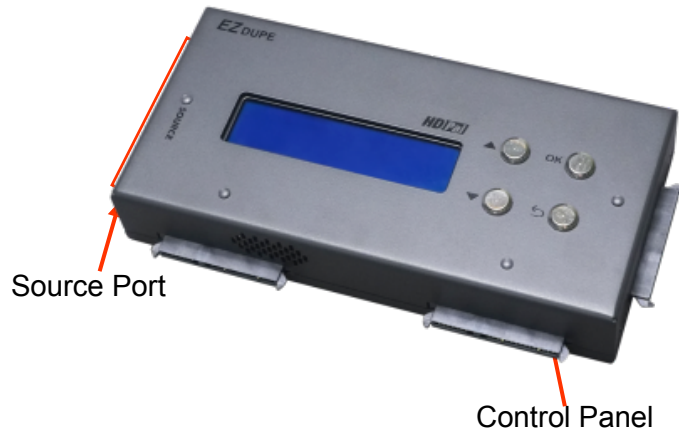

HD Pal Pro.

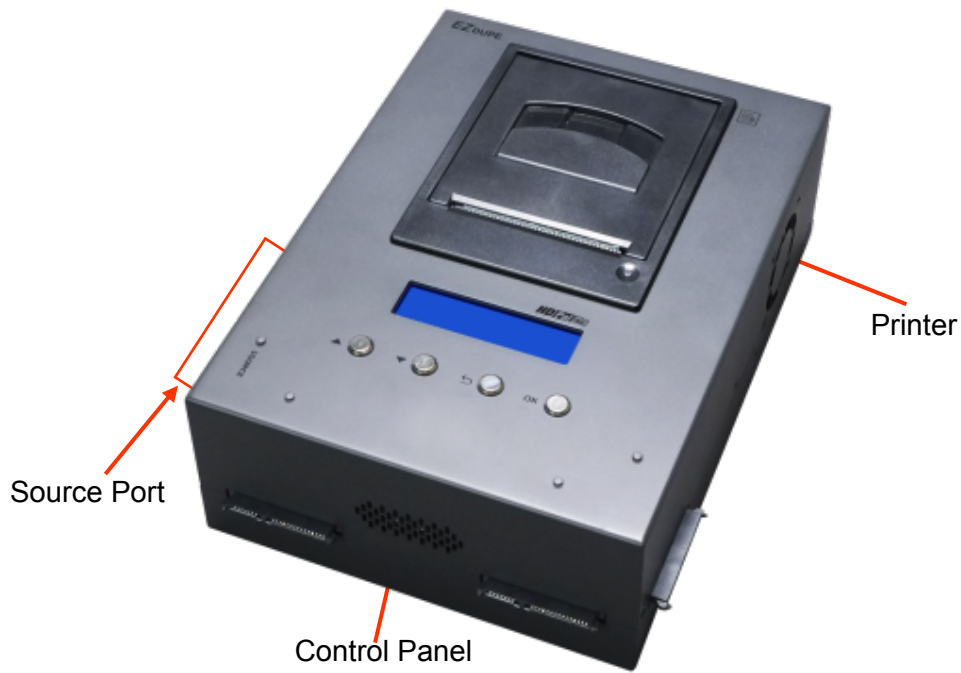



#### 4. Control Panel Overview

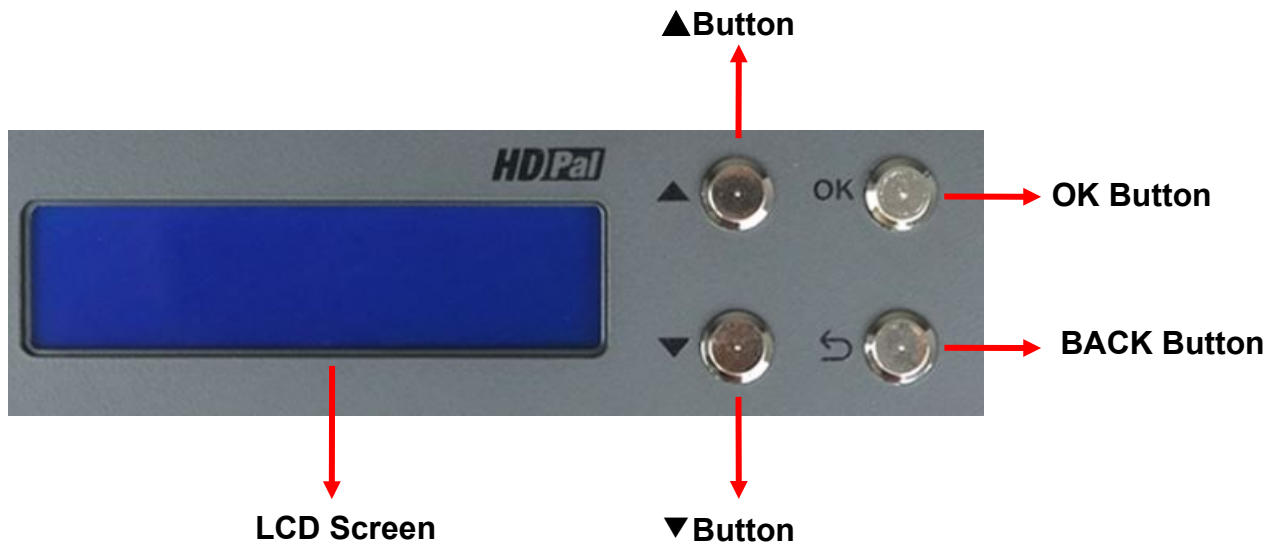

**▲Button:** *Up, Backward:* To navigate backward in the menu.

**▼Button:** *Down, Forward:* To navigate forward in the menu.

**OK Button:** *Enter, OK:* Execute the function.

**BACK Button:** *Escape, Cancel:* Go back to the previous level in the menu.

## 5. Specifications

<b>Operation</b>	Standalone (No PC or Software is required)
<b>Target</b>	HD Pal Jr. = 1, HD Pal = 3, HD Pal Pro = 3
<b>Transfer Speed</b>	HD Pal Jr. = 150MB/s HD Pal = 300MB/s HD Pal Pro = 600MB/s
<b>Copy Mode</b>	Synchronous
<b>Copy Area</b>	File and System, Percentage, All Partition, and Whole Media,
<b>Supported Media</b>	SATA 1, 2, 3 2.5" & 3.5" HDD
<b>Supported File System Format (for Intelligent Copy)</b>	Windows : FAT16/32, exFAT, NTFS Linux : ext2/3/4 MAC : HFS/HFS+/HFSX
<b>Display</b>	2-line Backlit Monochrome LCD
<b>Control Button</b>	4 push-button control panel (OK, BACK, UP, DOWN )
<b>Memory</b>	128MB DDR3

## II. Warning

1. The duplicator tasks mentioned in this user's manual are as following: Copy, Compare, Copy + Compare, Format and Erase.
2. All the tasks can be executed in synchronous mode, and asynchronous mode.  
The Green LED flashes during the execution process of a task. After the task is done, the Green LED will stay solid if the process is successful, otherwise the Red LED will be on if the process is failed.
3. Press and hold **BACK** button during the execution process of a task will stop and exit the execution of the task.
4. DO NOT unplug HD drive from the duplicator during the execution process of a task. It may cause damage to the duplicator system and media.
5. It is strongly recommended that the capacity of target storage device must be greater than or equal to the capacity of source storage device to avoid incomplete data backup.

### III. Operation Overview

The duplicator will start to execute a task after the source and target devices have been inserted and the OK button is pressed. The task will begin and end at the same time for all target devices. Any other target device plugged in during the process of a task will not be executed with the task.

- a. Insert source media into the source channel and blank media into the target channels properly. The LCD display will show no source disk when source media is not plugged in yet, and show the number of target media inserted when source media plugged in.
- b. The green LED will be on if the target device is plugged in properly.
- c. Select the task from menu, and press **OK** button to execute it.
- d. During the execution process, the status of each target device can be checked by using the ▲ and ▼ buttons.
- e. After the task is done, LCD display will show the number of successful and failed target(s), and execution time.

HD Pal Series provides 3 operation modes to be selected by users at **5.1 Operation Mode**. The selected operation mode will be shown on the LCD display.

#### 1. Disk to Disk

Performs a sector by sector copy of the source disk to target disks to produce exact duplicates of the source disc. Source disk sector 1 is copied to destination disk sector 1, then sector 2 is copied to sector 2, sector 3 to sector 3, and so on. It can do up to 3 targets duplications.

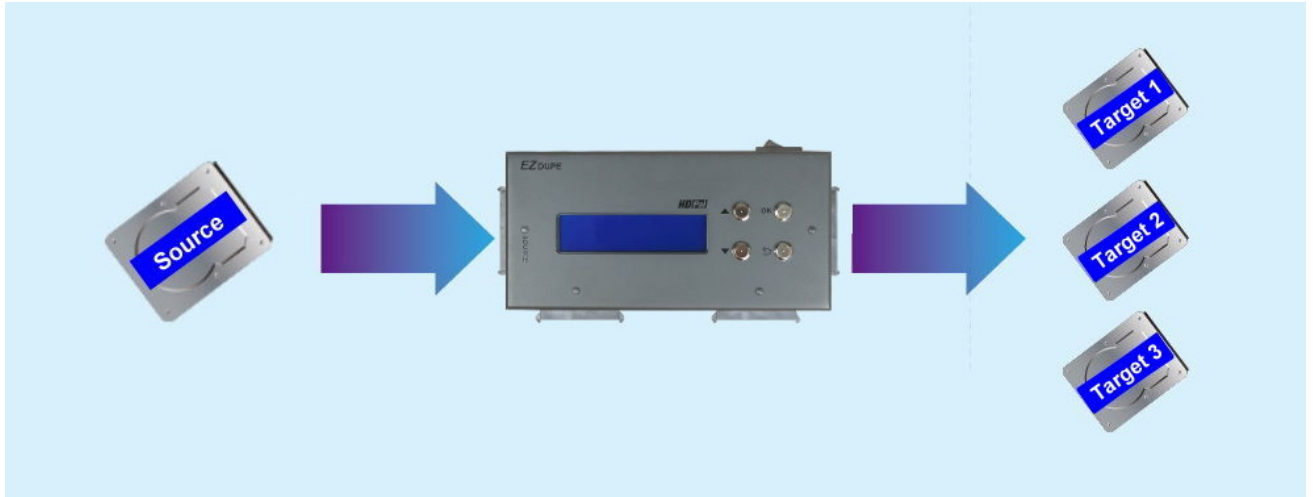

## 2. Disk to File

Images the source disk to a file and stores in a large image disc. The different image files can be stored in a large image disc in sequence. Images HDD 1 then HDD2 and then HDD 3 separately.

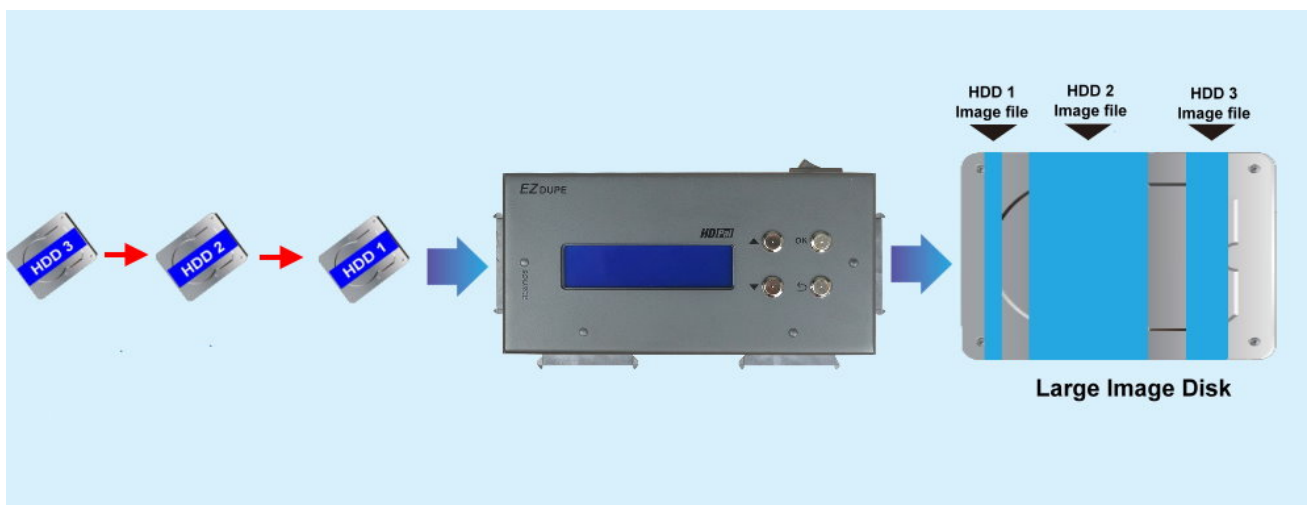

## 3. File to Disk

Restores image file from a large image disc to target disks. Users can choose one of the image file in the large image disc to be restored. Up to 3 target disks can be restored at a time.



## IV. Menu Overview

### 1. Duplicate

#### 1.1 Copy

##### A. Disk to Disk Mode :

Selects the operation mode at **5.1 Operation Mode**. It performs copying source disk sector by sector to target disks. The connection and operation procedure diagram are shown as below.

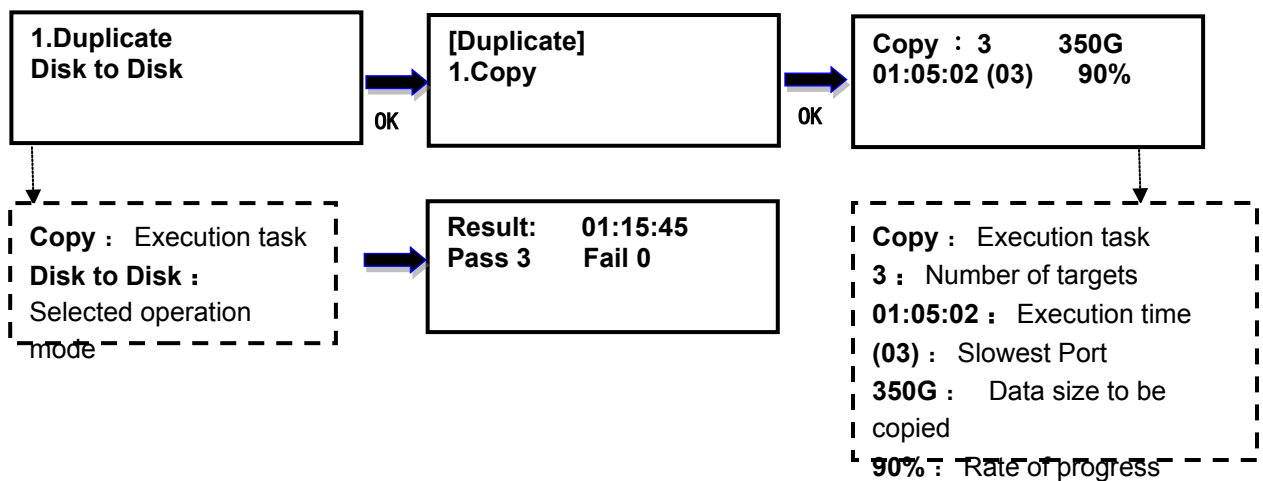
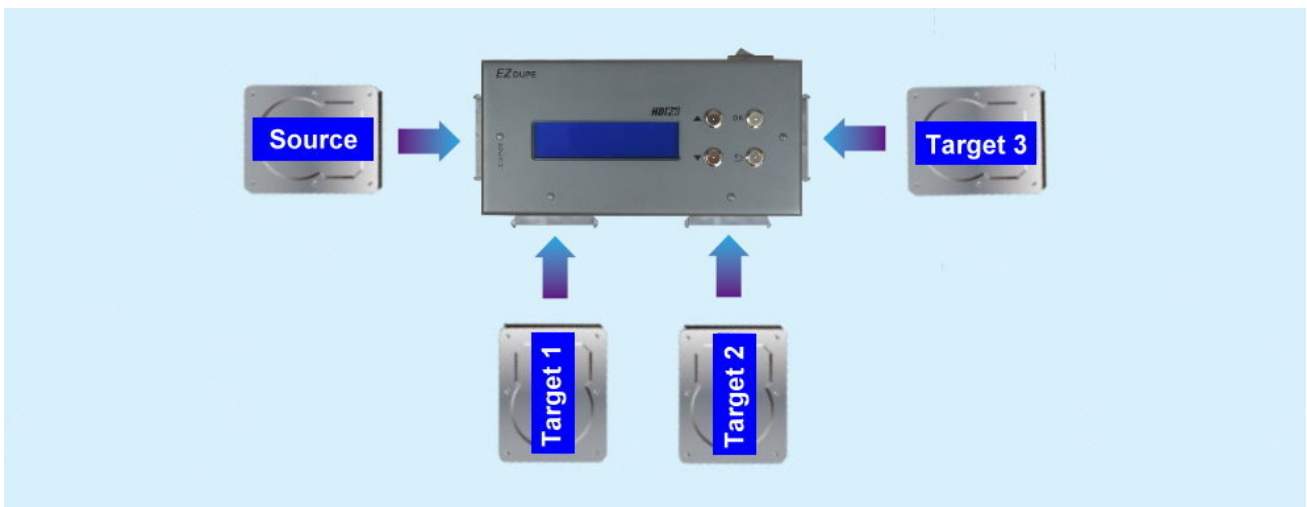

##### B. Disk to File Mode :

Selects the operation mode at **5.1 Operation Mode**. It performs imaging source disk to a file and stores in a large image disk. The operation procedure is the same as the above **Disk to Disk** mode. The connection diagram is shown below. Users can choose only backup available data or whole media at **5.2 Copy Area**. A file “IMG\_XXX.dup” (X from 0-9) will be produced.

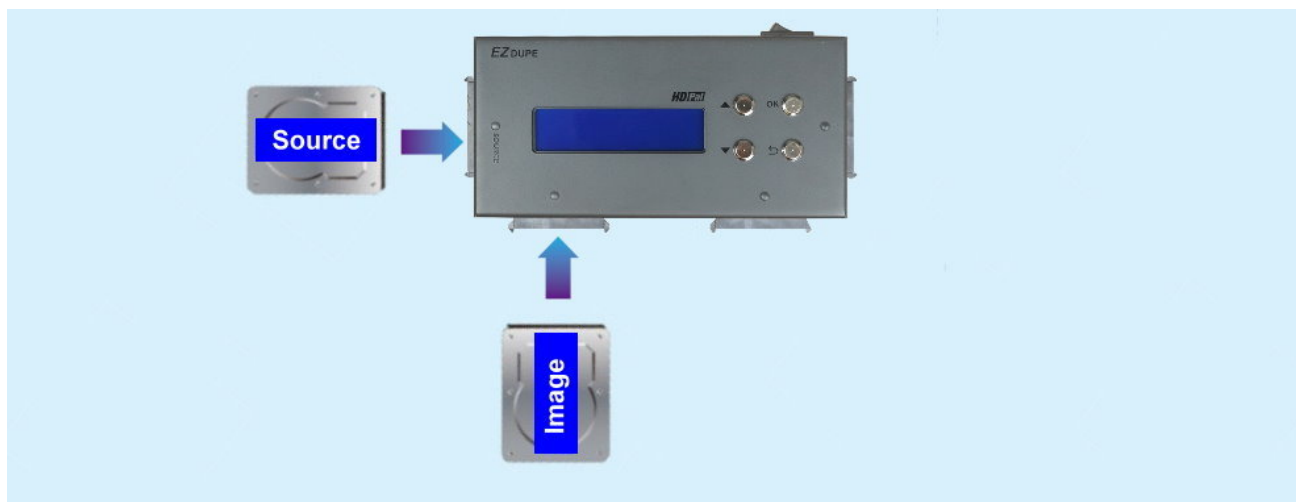

#### Remark :

- Source disk, the disk you want to image to a file, have to be connected to **source port**.
- Image disk, the file you want to be stored, have to be connected to **target port 1**.
- The format of Image HDD **MUST** be exFAT.

#### C. File to Disk Mode :

Selects the operation mode at **5.1 Operation Mode**. It performs restoring one of image file in an image disk to target disks. The operation procedure is the same as the above **Disk to Disk** mode. The connection diagram is shown below.



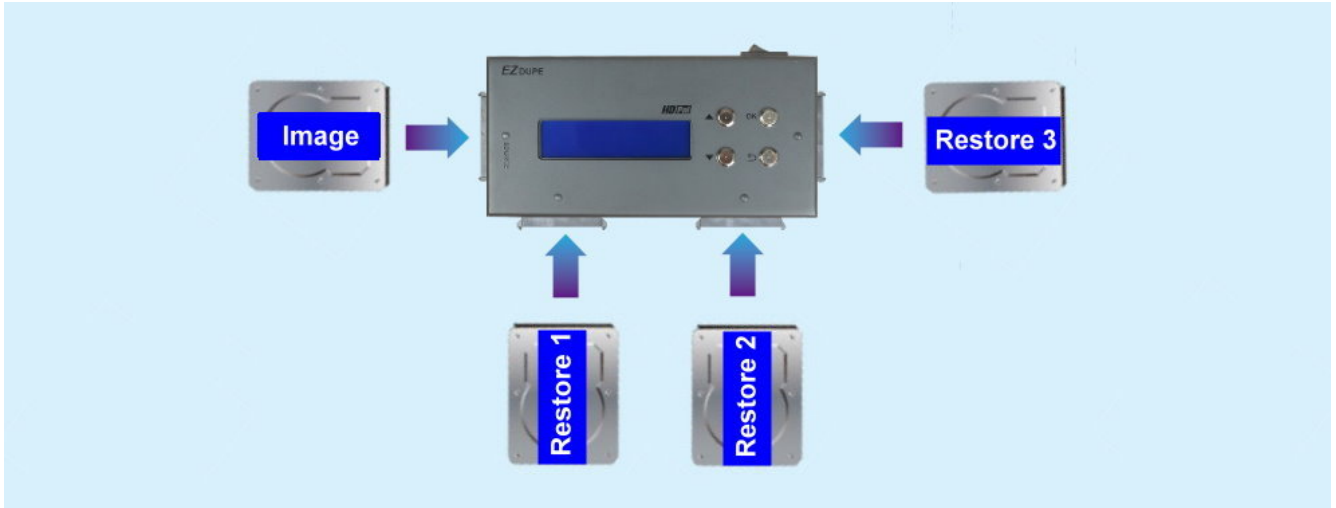

**Remark :**

- Image disk, the disk stored image files, have to be connected to **source port**.
- Restored disks, the targets disks you want to restore to, have to be connected to **target ports**, 1, 2, 3 disks are supported.

**1.2 Compare**

This function allows to compare the copied target disks against the source for accuracy. If a bad sector is determined on the source disk, the process of compare will be stop and show compare error. All connection and operation procedure diagrams are the same as **1. Copy**. Please refers to the above description.

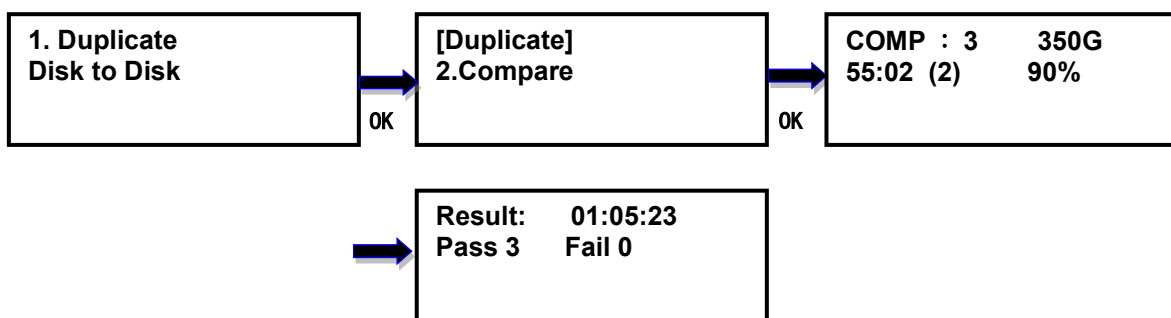

**1.3 Copy + Compare**

This function allows duplicator to start Copy process first, then follow with Compare process immediately. All connection and operation procedure diagrams are the same as **1. Copy**. Please refers to the above description.

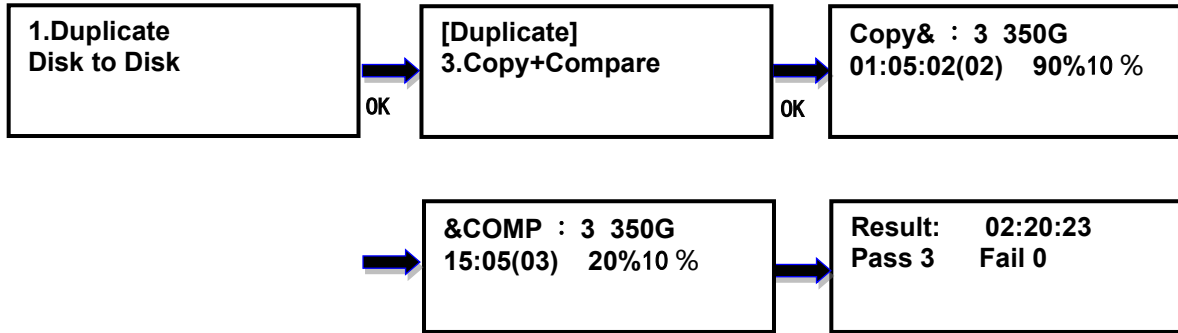

## 2. Data Erase

There are 8 erase methods to be selected by users according to their demands. When a bad sector was met during the erase process, the system will skip the bad sector and then keep erasing the following sectors. At the same time, the **RED LED** flashes. After the erase task is finished, the RED & GREEN LED keep light on.

### 2.1 Quick Erase

This option erases the table of content of file system of the target device, so it is fast to do Quick Erase. There is chance that some files can be retrieved by software.

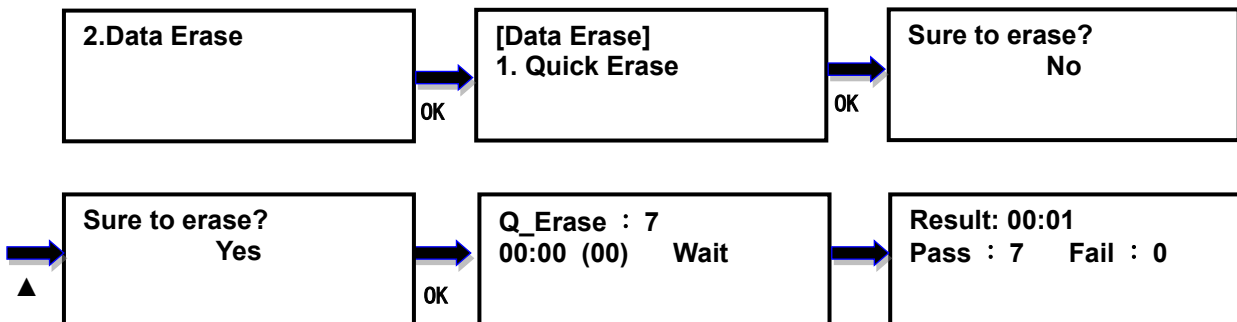

### 2.2 Full Erase

This option completely erases the content of target device. It takes longer time to erase and the content will not be retrieved by software.

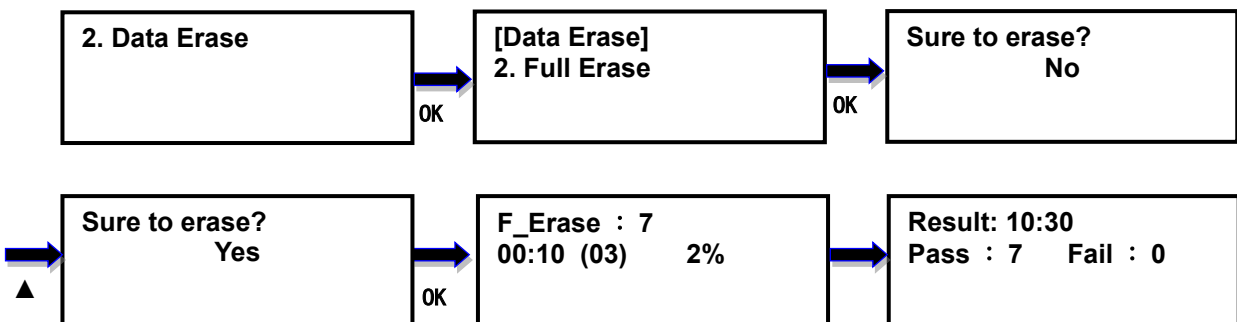

### 2.3 3-Pass DoD Erase

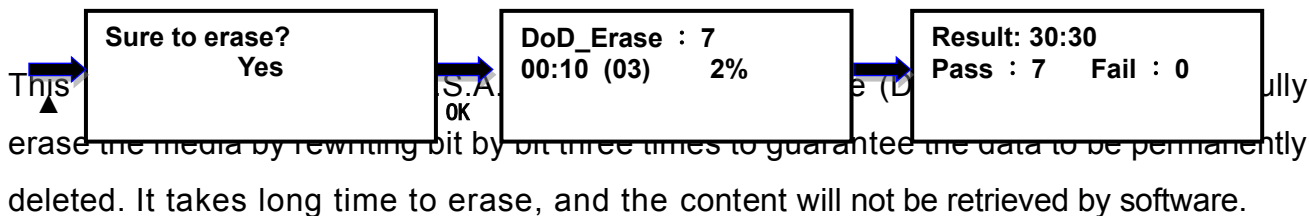
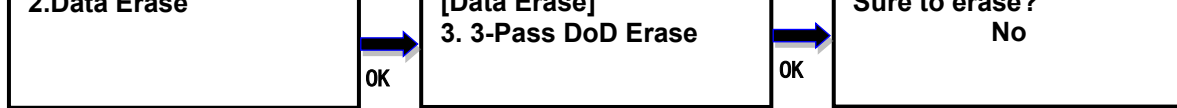

## 2.4 7-Pass DoD Erase

This is to comply with the U.S.A. Department of Defense (DoD 5220) standard to fully erase the media by rewriting bit by bit seven times to guarantee the data to be permanently deleted. It takes long time to erase, and the content will not be retrieved by software.

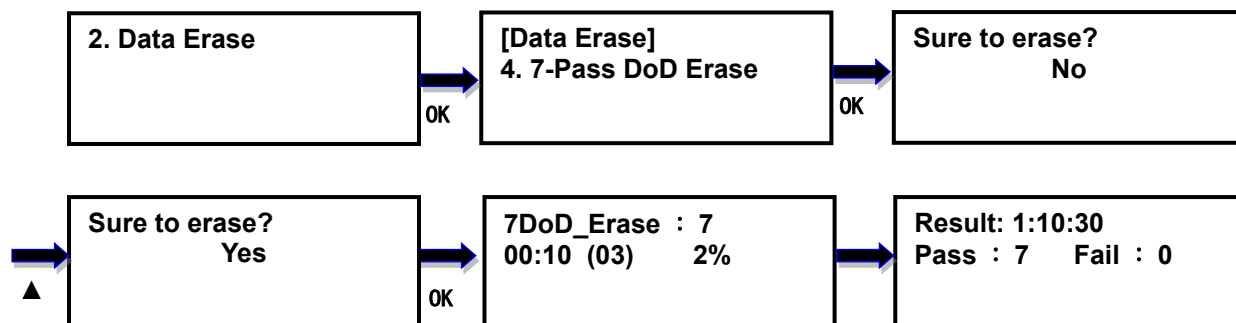

## 2.5 Secure Erase

The Secure Erase is dedicated to erasing SSD. It resets all its storage cells as empty - restoring the SSD to factory default settings and write performance. Secure Erase is recognized by the US National Institute for Standards and Technology (NIST), as an effective and secure way to meet legal requirements data sanitization attacks against up to laboratory level. It only spends few seconds (the real time depends on drive) when used for SSD.

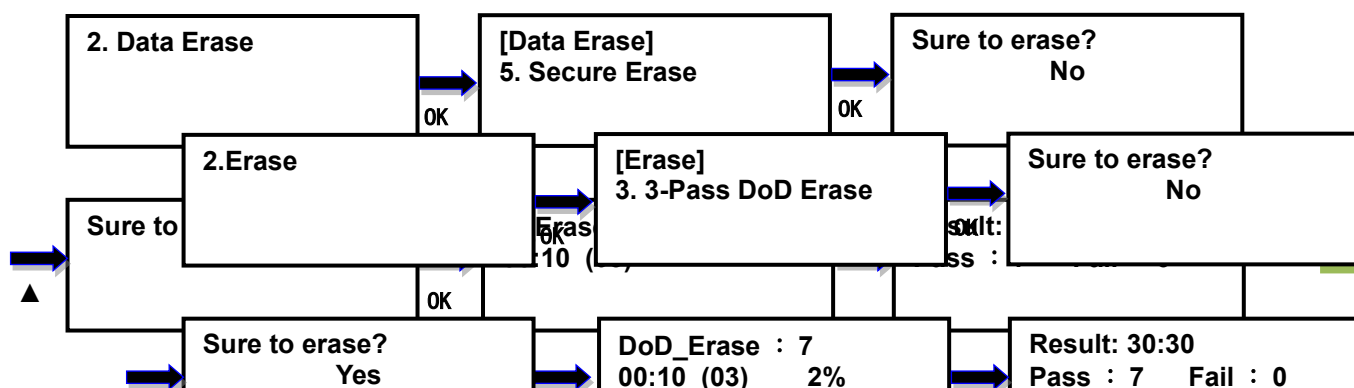

## 2.6 Enhance Secure Erase

The Enhance Secure Erase is similar to Secure Erase. Beside the function of Secure Erase, it shall write predetermined data patterns to all user data areas. All previously written user data shall be overwritten, including sectors that are no longer in use due to reallocation.

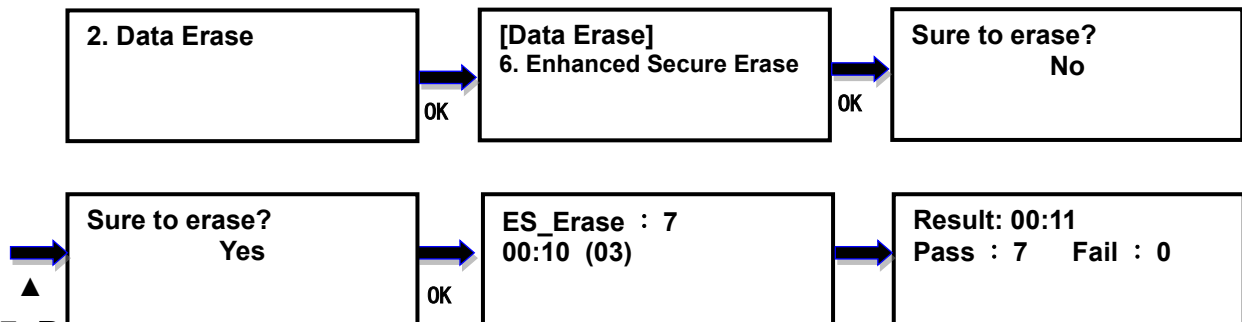

## 2.7 Remove HPA

This option removes the HPA setting of the disks inserted into the target ports.

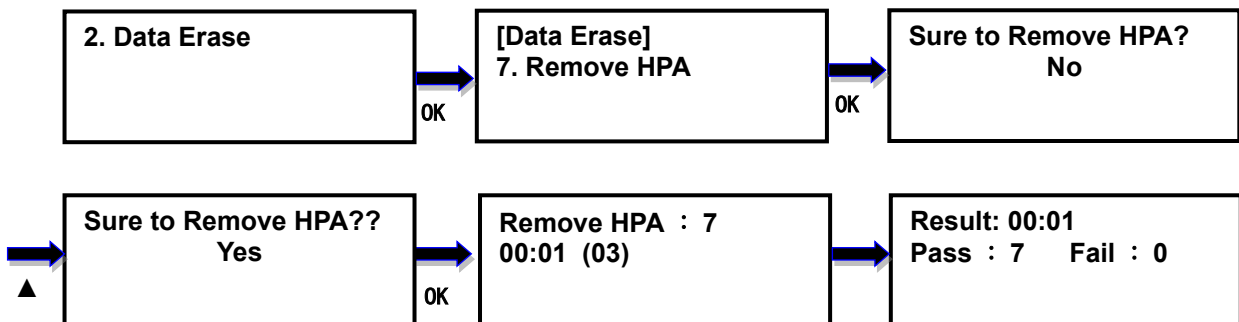

## 2.8 Remove DCO

This option removes the DCO setting of the disks inserted into the target ports.

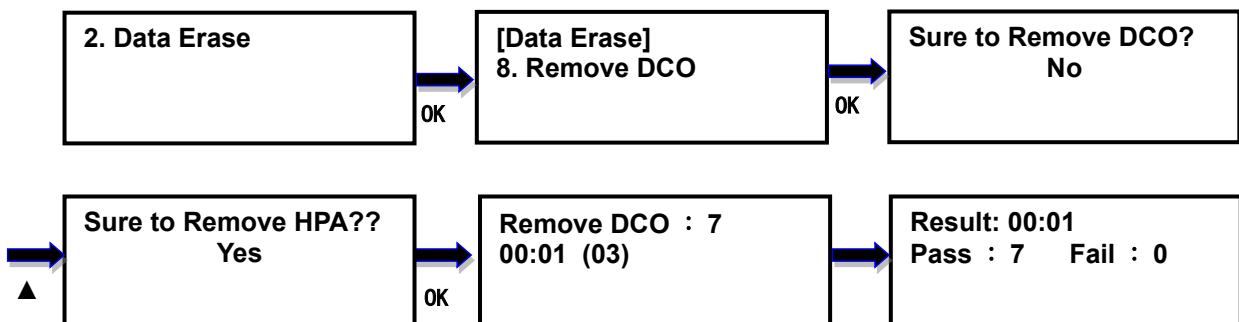

## 3. PC Mode (HD Pal / HD Pal Pro Only)

This function allows HD Pal works as a SATA to USB adapter (Source port). User can select it as a hardware Write Blocker or a common adapter. When Write Block, It can intercept and prevent (or 'block') any modifying command operation from ever reaching the source HDD. No data will be changed. Press **BACK** when you want to disconnect from the PC.

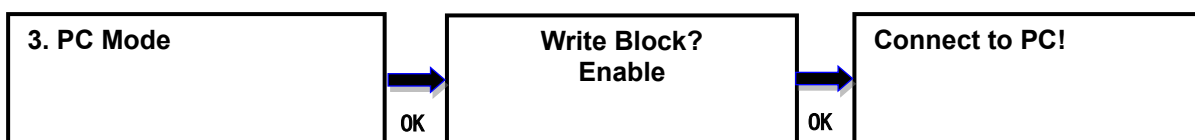

## 4. Utility

### 4.1 Format FAT32

This option allows to format the target device to FAT32 file format. It will not format the source device, avoiding accidentally erasing the original data content. User will be asked if it is sure to format the target devices before the Format process starts.

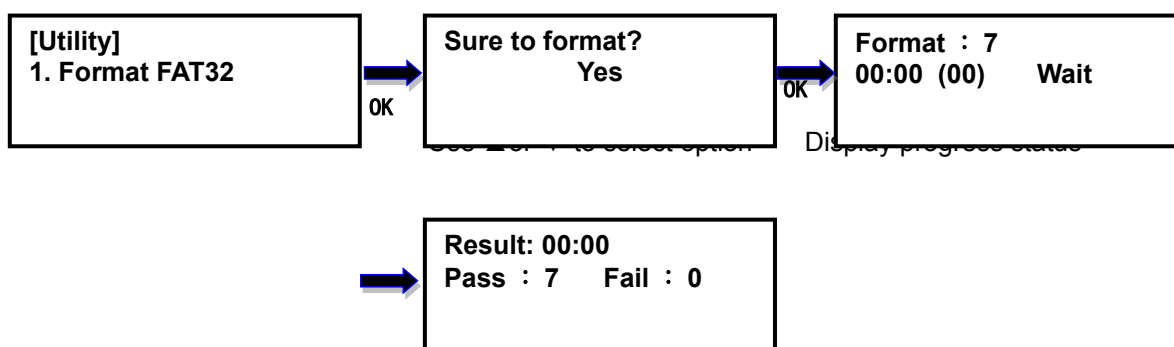

### 4.2 Format exFAT

This option allows to format the target device to exFAT file format. It will not format the source device, avoiding accidentally erasing the original data content. User will be asked if it is sure to format the target devices before the Format process starts.

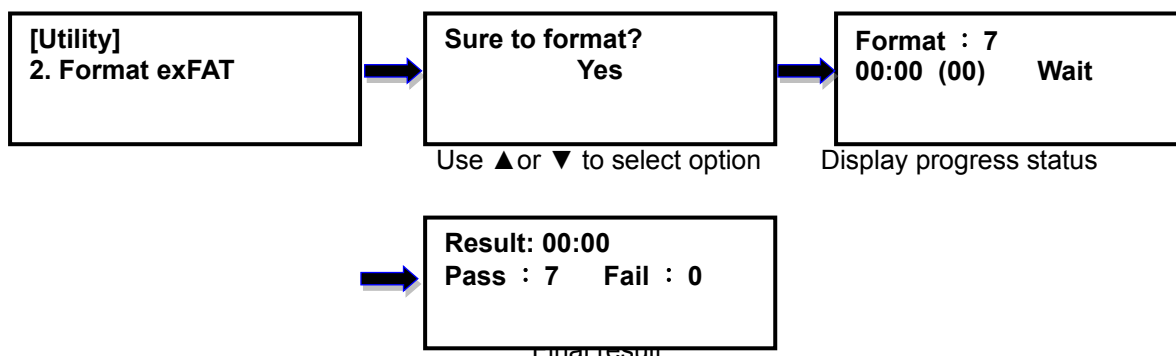

### 4.3 Measure Speed

This option allows to measure the actual Read and Write speed of the target device. This option will NOT alter or erase existing data on the target device.

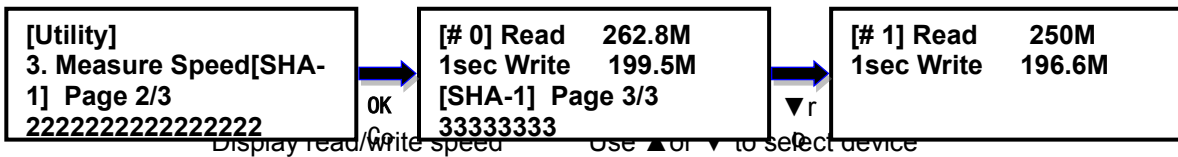

### 4.4 Media Information

This option displays the information of selected device media, such as total capacity, file format and the size of data content.

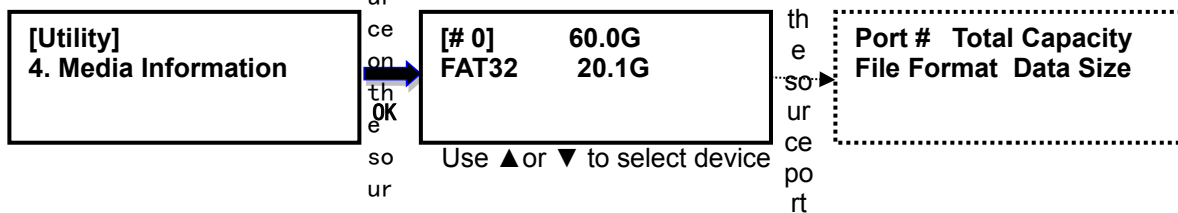

### 4.5 Device Information

This option displays the device information of the selected device. The information are listed as follows. **Model Number, Firmware Version, Serial Number, Power Cycle Count, Power-on Hours, Reallocation Event Count, Offline Scan Uncorrectable Sector Count, Seek Error Rate, Temperature.**

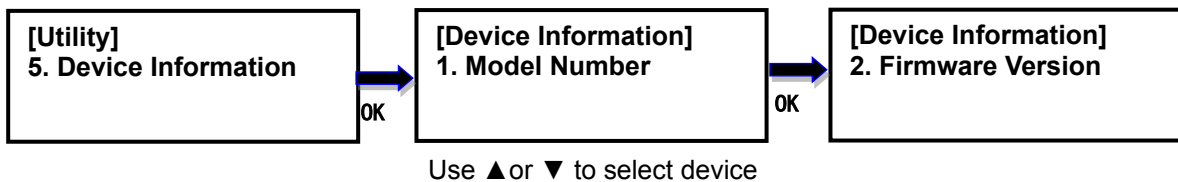

### 4.6 Log Manager (HD Pal / HD Pal Pro only)

The duplicator keeps logs in the flash memory of Copy, Compare, Copy+Compare, Erase, and Format function. 10,000 records of log data can be stored. The records of log data for a task is the number of source+targets+1. For example : 1 to 3 copy task needs 1+3+1=5 records. 3 exFAT format task needs 0+3+1=4 records. The log file is **read only**. Users cannot modify the log data.

#### 4.6.1 Load Data

Insert a disk into the **target port 1**. The file system of the disk must be FAT32 or exFAT.

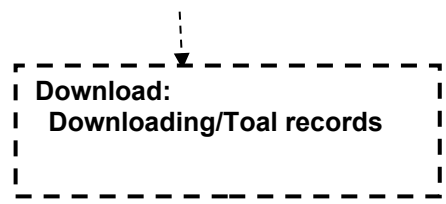

**Result:**  
**Pass: 1    Fail: 0**

**Download:**  
**Downloading/Toal records**

Open the file from computer. The file name of log file is “LOG\_DATA\_XXX.txt”. XXX is from 000 to 999 in sequence. If no log file in the disk, it starts from 000. If 000 is exist in the disk, it will be added 1 to be 001 and so on. The information in log file is shown below. It was recorded for 1 to 3 Copy and uses 5 log records.

[Log File]

Machine Model: HD Pal  
 Target Number: 3  
 Firmware Version: v2.00.16  
 Machine ID: 84E15PF8SMS6RBA1

Machine boot at 2021/4/09 16:07

Task: Copy

Operation Mode : Disk to Disk  
 Copy Area: System and Files  
 Smaller Target: Can Not Copy  
 Unknown Format: Copy  
 HPA: Skip  
 DCO: Disable  
 Performance: Speed  
 Mode: Synchronous

Source:

Device Model: ADATA SP550  
 Series Number: 2F3820030313  
 Capacity: 111.7G  
 Data size: 30M

Result:

Total: 2  
 Pass : 0  
 Fail : 2  
 Spend Time : 00:00:04

[Detail Target Records]

Port	Result	Start Time	Spend Time	Device Model	Target Capacity	Series Number
-						
0002	Pass	2021/04/09 16:09	00:00:04	PLEXTOR PX-128M5Pro	119.2G	P02314109173
0003	Pass	2021/04/09 16:09	00:00:04	SanDisk SSD U110 64GB	58.6G	140791403873
0001	Pass	2021/04/09 16:09	00:00:04	ADATA SP550	111.7G	2F3820030313

## 4.6.2 Clear Data

This option clears all the log data in duplicator.

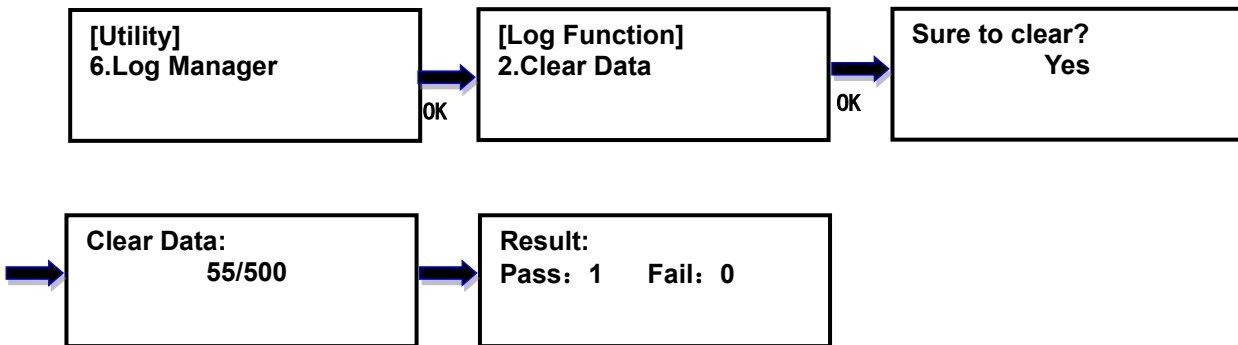

### 4.6.3 Space Info

This option shows the number of log records and amount of free space available.



### 4.7 File Manager

This option is the management of the image disk. It appears in the menu when **Operation Mode** is set as **Disk to File** or **File to Disk**. The position of image disk (image port) depends on the operation mode, insert the image disk into the image port. All the function in this option read from image port.

**Disk to Disk** No image related function so *none port* is the image port.

**Disk to File** *Target port 1* is the image port.

**File to Disk** *Source port* is the image port.

#### 4.7.1 Select File

This option is used at **File to Disk** operation mode, selects the file which you want to be restored to the target disks. Select a file IMG\_XXX.dup. The files are listed in order of which they were imaged.

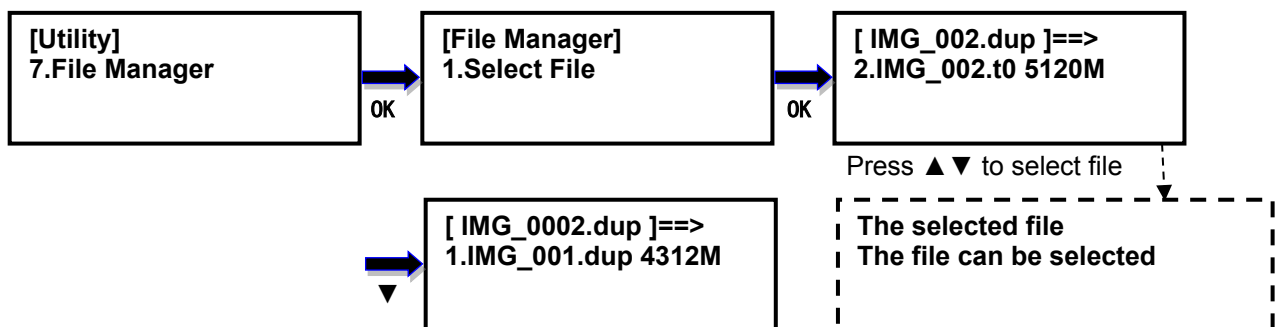



### 4.7.2 File Information

Shows the files in sequential order. It shows the file name and size of IMG\_XXX.dup.

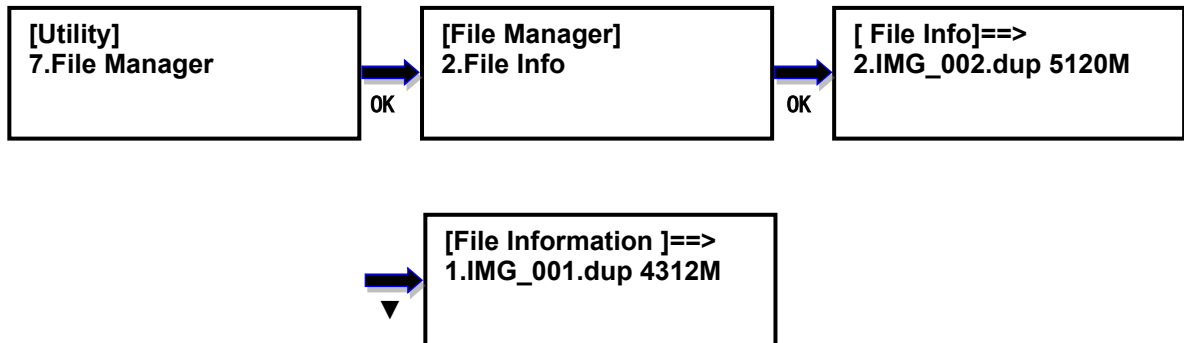

Press ▲ or ▼ to check the files in the image disk

### 4.7.3 Rename File

Rename the file instead of using default file names (IMG\_001, IMG\_002, etc.).

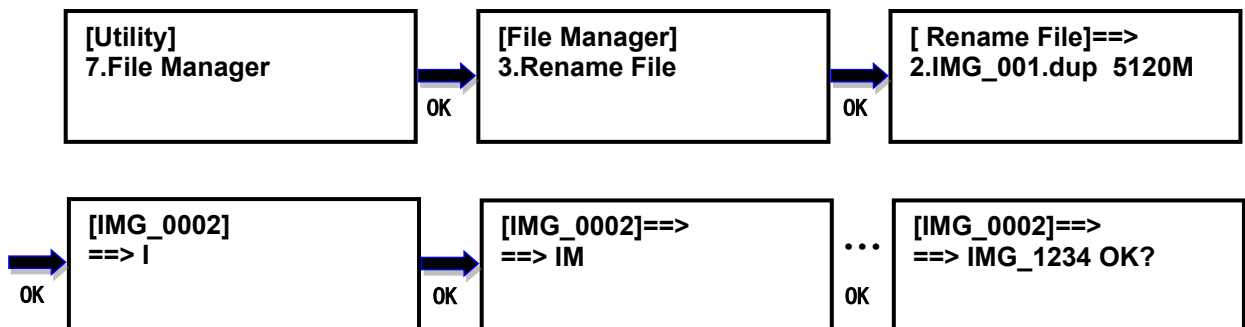

Press ▲▼ to select character    Press OK to next character    Press OK to confirm

**Remark :** Press BACK to back to last character when rename file name.

### 4.7.4 Delete File

Delete the file in an image disk.

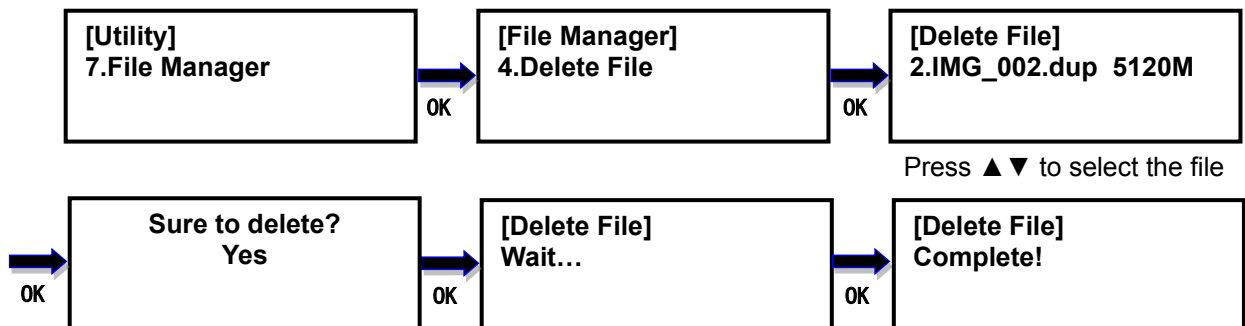

Press ▲▼ to select the file

Use ▲ or ▼ to select option

### 4.7.5 Disk Info

Show the number of files and amount of free space available.

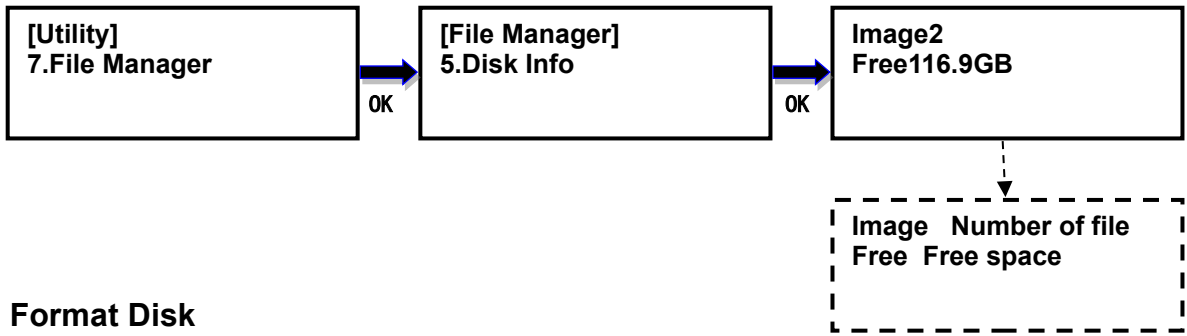

#### 4.7.6 Format Disk

Format the disk connected to image port. The format file system is exFAT.

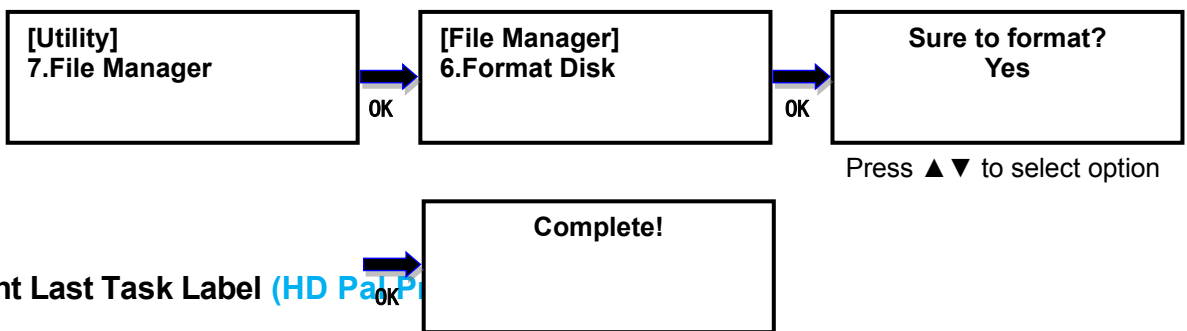

#### 4.8 Print Last Task Label (HD Pal Print)

If the label quality is not good enough of the last task, this option allows user to print the label(s) of the last task again.

#### 4.9 System Info.

This option displays general information of the duplicator, including controller model, system memory size, firmware version, number of targets and ID Number.

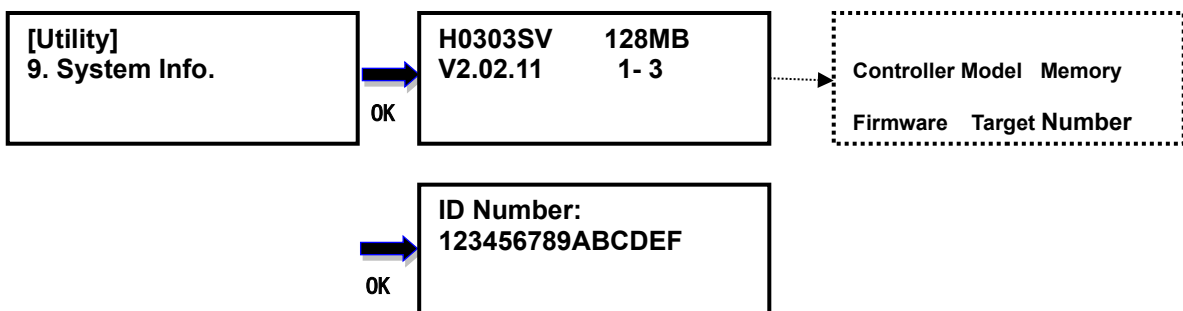

#### 4.10 System Update

This option allows user to update the firmware of duplicator when necessary. Please obtain the proper firmware file from manufacturer, and save the unzipped file under home folder on the HDD (The file system of should be FAT32). Insert the HDD containing the firmware into the source port of duplicator and press OK. It will update the system,

reboot the duplicator automatically after update, active and operate under the new firmware. **Please do not reboot the duplicator manually.**

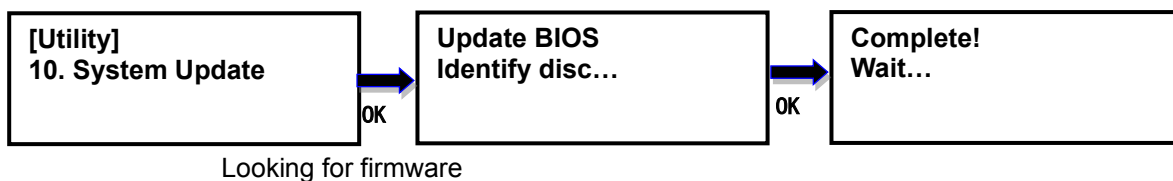

## 5. Setup

### 5.1 Operation Mode

There are 3 operation modes can be selected. **Disk to Disk**, **Disk to File** and **File to Disk**. The details please refer to **Chapter 2**. The default mode is [Disk to Disk](#)

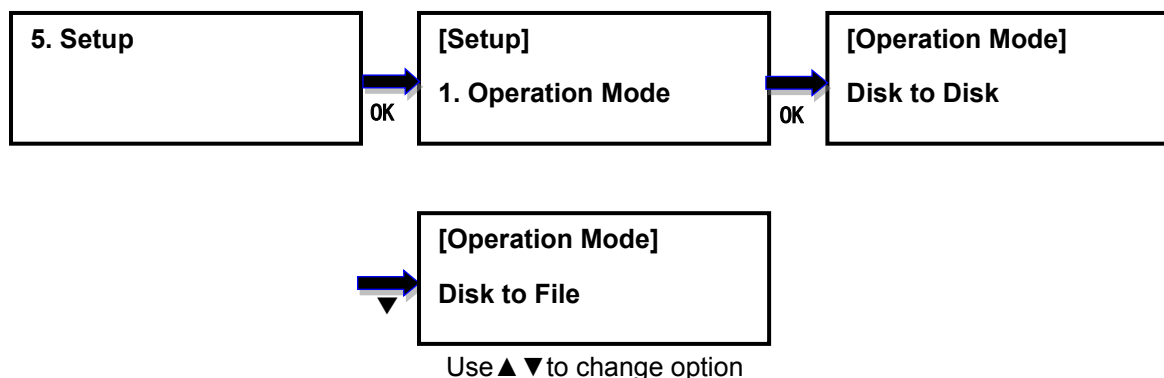

### 5.2 Copy Area

This option allows to select the area on the source device to copy onto the target devices. You may select **System and Files** to skip all the unoccupied area on the source device or **Percentage**、**All Partition**、**Whole Media**. By default, the copy area is set up as [System and Files](#).

#### System and Files

The duplicator first analyzes the file format of source device. You may copy only the system and files area to save overall copy time if the file format is FAT16, FAT32, exFAT, NTFS (Windows), EXT2, EXT3, EXT4 (Linux), and HFS/HFS+/HFSX (Mac). For instance, the source device has 8GB capacity but with only 50MB of data in FAT32 file format. The duplicator will copy only the 50MB of data area to the target device, hence shortening overall copy time.

## Percentage

When selected, the duplicator copies the selected percentage range. Users can set copy percentage at this item. It has nothing with data or empty spaces.

## All Partition

When select, the duplicator copies all partitions in the drive. It will not copy the area that have not been partitioned.

## Whole Media

When selected, the duplicator copies the entire content on the source device, including both the data and empty spaces. This option is used when you have a source device with unknown file format. For instance a source device has 8GB capacity and 50MB of data with unknown file format, the duplicator will copy the whole 8GB of content to target device.

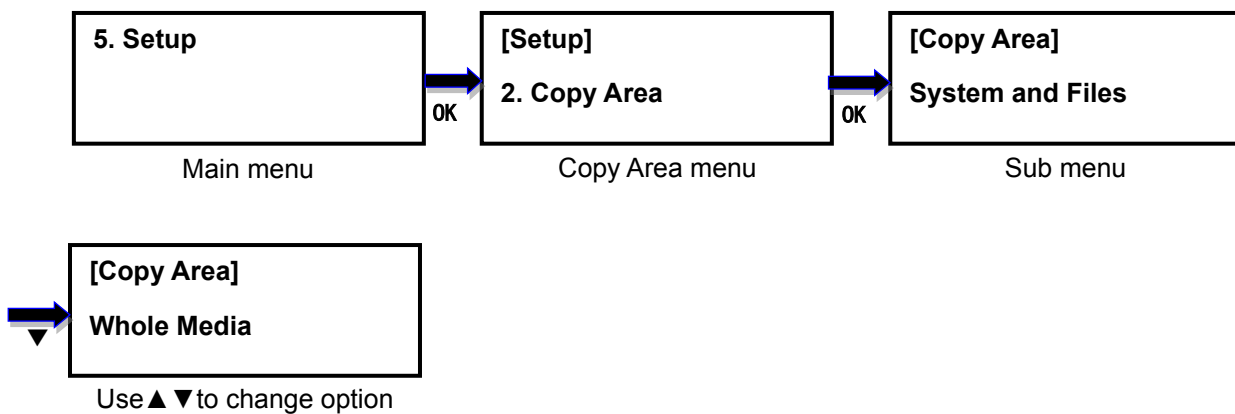

### 5.3 Smaller Target

If the capacity of the target device is smaller than the source device, the duplicator will partly copy or cannot copy. [Can Not Copy](#) is the default setting.

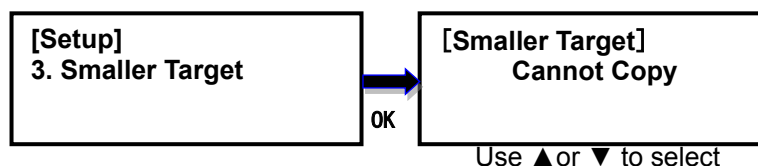

### 5.4 Unknown Format

This option allows you to Copy or Skip unknown format. If option Skip is selected here, the unknown format from source will not be copied during copy process. [Copy](#) unknown format is the default setting.

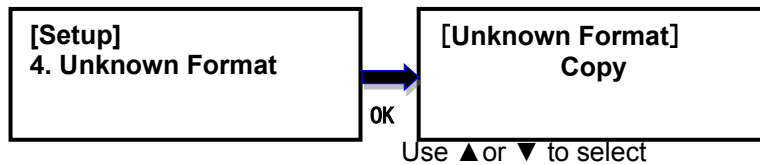

## 5.5 HPA Set

HPA, Host Protected Area or Hidden Protected Area, is kept invisible space for booting area, recovery data or blocked bad-sector, etc. By creating HPA, it resets max sectors and keeps some space for HPA. It reduces the reported size of HDD. There are 4 settings in this function. The HPA setting and data stored in HPA of source HDD will not be modified.

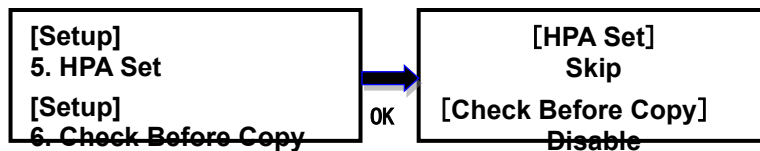

### Skip (default)

Copy data from source to target except data stored in HPA and keep the target HPA setting during Copy.

### Clear Target HPA without Copy

Copy data from source to target and remove the target HPA setting during Copy

### Set Target HPA without Copy

Copy data from source to target and set the target HDD the same HPA setting as the source HDD during Copy.

### Copy

Copy data from source to target including data stored in HPA.

## 5.6 DCO Set

This option allows you to enable or disable set DCO. If option **Disable** is selected here, the DCO set from source will not be copied during copy process. If **Enable** is selected, the set DCO will be copied to all target HDDs. **Disable** set DCO is the default setting.

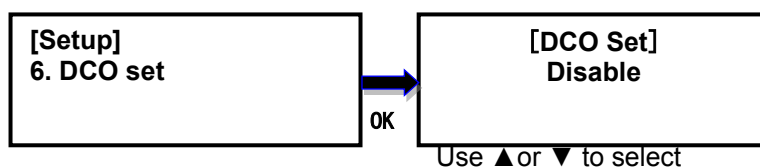

## 5.7 Allow Reader Bad Sector

This option allows you to Stop or Skip the Copy Process when source disk has bad sector. **Stop** is the default setting.

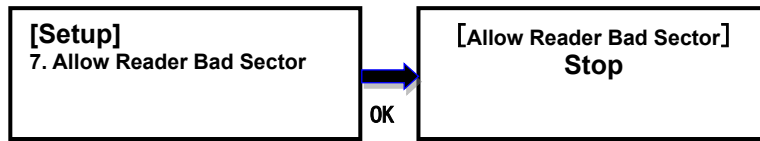

### 5.8 Erase Master

This option allows you to set if the master disk can be erased or not. **Disable** is the default setting.

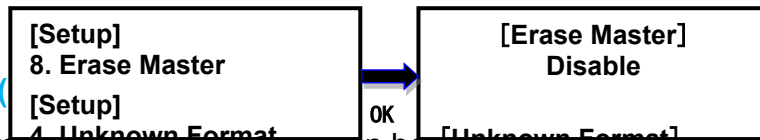

### 5.9 Label Print

This option allows you to set if the label can be printed after a task is finished. **Disable** is the default setting.

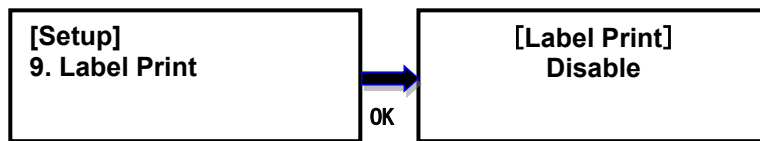

### 5.10 Start-up Menu

Choose one of the following as the default start-up function: Duplicate, Data Erase, Quality Check, Utility and Setup. The default start-up function is **Duplicate**.

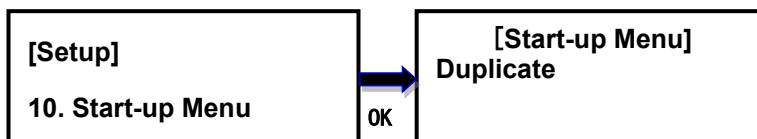

Use ▲ or ▼ to select

### 5.11 Button Beep

This option allows to set up button sound from the following options: Button & Warning, OFF, Warning only. The default setting is **Button & Warning**.

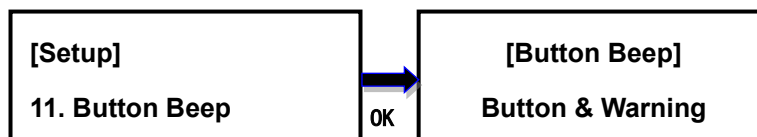

Use ▲ or ▼ to select

## 5.12 Language

This option allows to choose the language for display: English, Spanish, Portuguese, and Japanese. **English** is the default language.

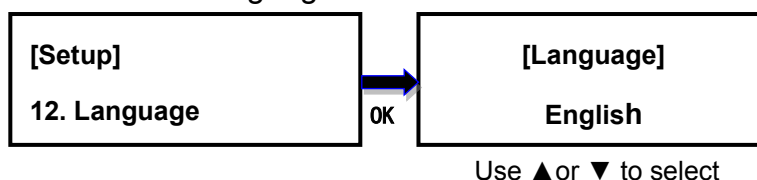

## 5.13 Clear Setup

This option resets the duplicator back to factory default settings.

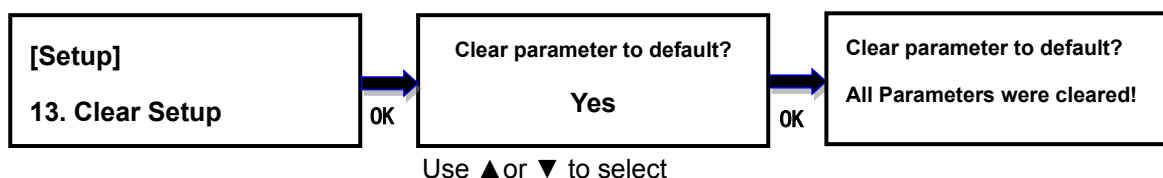

## 5.14 Set Date Time (HD Pal / HD Pal Pro only)

This option sets the date and time of the duplicator. It has a battery to provide power to the clock when no power adapter is connected.

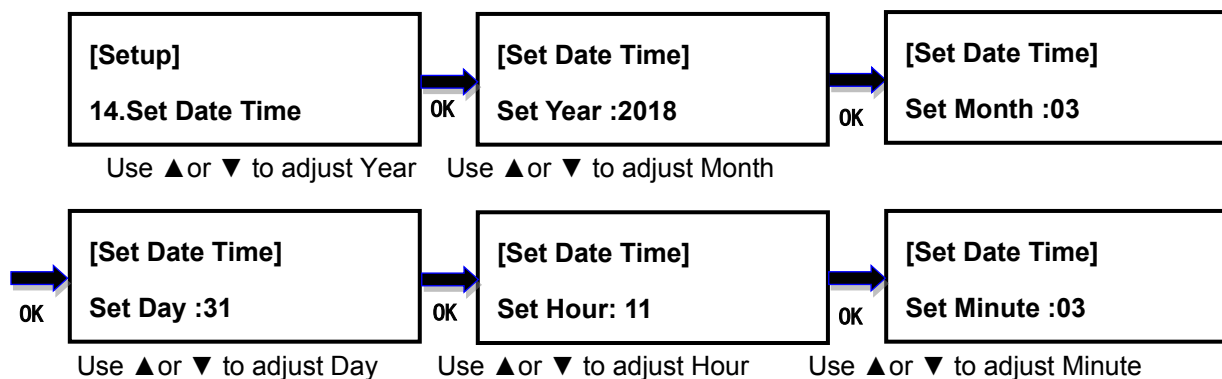

## 5.15 Performance

This option allows to set up the performance for Copy function based on the following modes: Speed, Balance, and Compatibility. Speed mode is to execute the Copy function at the fastest speed, but may have compatibility issue with certain brands flash media. Balance mode is to execute the Copy function at stable speed, and have less compatibility issue with certain brands flash media. Compatibility mode is to execute the Copy function at

the most stable speed, and almost have no compatible issue with flash media. The default mode is **Speed**.

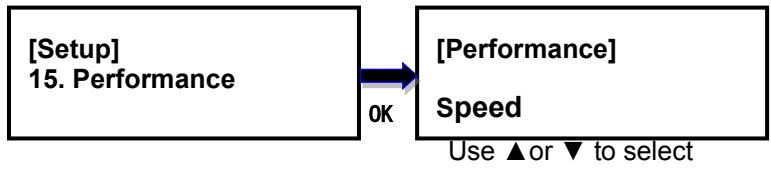



## v. Troubleshooting

When the duplicator malfunctions or you have questions about using the duplicator, you can first check the following related problems and eliminate them. If you still have problems, you can contact the EZ Dupe technical support department. The contact information is listed at [www.ezdupe.com](http://www.ezdupe.com).

### **Q1 : Why there is no display and nothing happens when the power switch is turned on?**

1. Please make sure that the power cord is tightly connected to the duplicator, and the power outlet works normally.
2. Please check whether the duplicator power voltage selection switch is in the correct position 110V or 220V. Please adjust it according to the local voltage.
3. Make sure that the power cord is not damaged.

### **Q2 : Why can't the duplicator recognize the media device?**

1. Please check if the media device can be used normally on a computer.
2. Please insert the media device into different ports for testing. If some ports can recognize the media device and some cannot, it may be that some ports have been used for too long, resulting in poor connection. Please send duplicator in for repair. If all of the ports are unrecognized, it may be the compatibility issue. Please set the Performance mode to Compatibility in 5. Setup -> 22. Performance in the main menu. If it is still unrecognizable, the media device may be of poor quality and not compatible with this duplicator. Please replace the media device with another brand.

### **Q3 : Why is the copy failure rate high?**

1. The media device quality may be poor, please change it to other brands with better quality.
2. The duplicator has been used for a long time, resulting in poor port contact with media device. Please send it to the manufacturer for inspection.

### **Q4 : Why is the copy speed slow?**

1. The copy speed depends on the writing speed of the media device. When the writing speed of the media device is slow, the copy speed becomes slow.
2. There may be a slower media device in the batch of media. Remove it (press the up and down keys at the same time to remove the slowest media device during copy process) to speed up.

**Q5 : Why the media device cannot be used normally after copying?**

During the copying process, the duplicator reads the data from the source media device and then writes to the target media device. An error may occur during the writing process, or the target media device has bad sectors and cannot be written normally. It is recommended to use the Compare function to ensure that the data copied to the target media device is 100% the same as the source media device.

**Q6 : Why is copy failed?**

1. Data on the source media device cannot be read normally. The source media device may be of poor quality or has bad sectors. The copying process to all target media devices will stop.
2. Target media device cannot be written normally. The target media device may be of poor quality or has bad sectors. The copying process of this target media device will stop, and others will continue to copy.

**Q7 : Why can't I update the firmware?**

1. Different duplicators have different update files, please make sure your update files are correct.
2. Please make sure that the media file system is **FAT32**, the update file is uncompressed (the file extension is .BIN) and saved on the root directory of the media device.